



# User Manual

## Spring series LFP Battery







### SE-G5.1 Pro-B



## Read and follow these instructions!

The following precautions are intended to ensure your safety and prevent property damage.

Before installing this product, be sure to read all safety instructions in this document for proper installation.

	<b>⚠ DANGER</b> Failure to comply with the instructions with this symbol may result in a serious accident, causing death or a severe injury.
	<b>⚠ WARNING</b> Failure to comply with the instructions with this symbol may result in a serious accident, causing a severe injury.
	<b>⚠ CAUTION</b> Failure to comply with the instructions with this symbol may result in minor or moderate injury.
	<b>NOTICE</b> Provides information considered important but not hazard-related. The information relates to property damage.
	Read instruction before use
	Risk of electric shock
	Operate as specified by the manual

This product is designed to an integrated system, which must be performed by a qualified person trained in electrical engineering and familiar with the characteristics and safety requirements of lithium batteries. Do not use this product if you are unsure if you possess the necessary skills to complete this integration.

# Table of Contents

1. Precautions .....	- 3 -
1.1 General Safety Precautions .....	- 3 -
1.2 Installation Precautions .....	- 3 -
2. Product Introduction .....	- 4 -
2.1 Front Panel Function Introduction .....	- 4 -
2.2 Product Specifications .....	- 5 -
2.3 State Indicator .....	- 6 -
3. Unpack the Battery .....	- 6 -
3.1 Parts List.....	- 7 -
3.2 Visual Inspection of the Modules .....	- 8 -
4. Battery Installation.....	- 8 -
4.1 Battery Module Installation.....	- 9 -
5. Cable Connection.....	- 13 -
5.1 Single Battery Connection.....	- 13 -
5.2 Connect Cables of the Multiple Batteries in Parallel.....	- 15 -
5.3 Visual Inspection of the Connection .....	- 18 -
6. Activate the Product .....	- 18 -
6.1 Start the Battery.....	- 18 -
7. Inspection, Cleaning and Maintenance.....	- 19 -
7.1 General Information .....	- 19 -
7.2 Inspection .....	- 19 -
7.3 Cleaning .....	- 19 -
7.4 Maintenance .....	- 20 -
7.5 Storage.....	- 20 -
8. Troubleshooting .....	- 20 -
9. Battery recovery .....	- 21 -
9.1 Recovery process and steps of cathode materials .....	- 21 -
9.2 Recovery of anode materials .....	- 22 -
9.3 Recovery of diaphragm.....	- 22 -
9.4 List of recycling equipment:.....	- 22 -
10. Transportation Requirements .....	- 22 -

# 1. Precautions

## 1.1 General Safety Precautions

The product provides a safe source of electrical energy when operated as intended and as designed. Potentially hazardous circumstances such as excessive heat or electrolyte mist may occur under improper operating conditions, damage, misuse and/or abuse. The following safety precautions and the warning messages described in this part must be observed.

If any of the following precautions are not fully understood, or if you have any questions, contact us for guidance.

### Risks of explosion

- Do not subject the battery to strong impacts.
- Do not crush or puncture the battery.
- Do not dispose of the battery in a fire.

### Risks of fire

- Do not expose the battery to temperatures in excess of 60°C.
- Do not place the battery near a heat source such as a fireplace.
- Do not expose the battery to direct sunlight.
- Do not allow the battery connectors to touch conductive objects such as wires.

### Risks of electric shock

- Do not disassemble the battery.
- Do not touch the battery with wet hands.
- Do not expose the battery to moisture or liquids.
- Keep the battery away from children and animals.



### Risks of damage to the battery

- Do not allow the battery to encounter liquids.
- Do not subject the battery to high pressures.

## 1.2 Installation Precautions

Please be aware that a battery presents a risk of electrical shock including high short-circuit current. Follow all safety precautions while operating the batteries.

- Remove watches, rings, and other metallic accessories.
- Use tools with insulated handles in order to avoid inadvertent short circuits.
- Wear rubber gloves and safety boots.
- Do not put tools or any metal parts on the top of the batteries.
- Disconnect charging source and load before connecting or disconnecting terminals.
- When moving batteries and wear all appropriate safety clothing and equipment.
- Do not open or mutilate the batteries.

	
	<ul style="list-style-type: none"> <li>▪ Verify polarity at all connections before energizing the system. Reverse polarity at the battery terminals will void the Warranty and destroy the batteries. Do not short circuit the batteries.</li> <li>▪ Do not combine Lithium Batteries with other brands or chemistries; Do not mix Lithium Batteries from different installations, clients, or job sites.</li> <li>▪ Do not disassemble or modify the battery. If the battery housing is damaged, do not touch exposed contents.</li> </ul>

## 2. Product Introduction

51.2V series lithium iron phosphate battery system has been designed to provide power backup for remote or outside telecom plants like Access Terminals, Base Transceiver Stations, and Base Station Controllers. This system has the characteristics of high system integration, well reliability, long service life, and wide operating temperature range.

### 2.1 Front Panel Function Introduction

In order to operate the product correctly, please carefully view the function of the front panel of the battery.

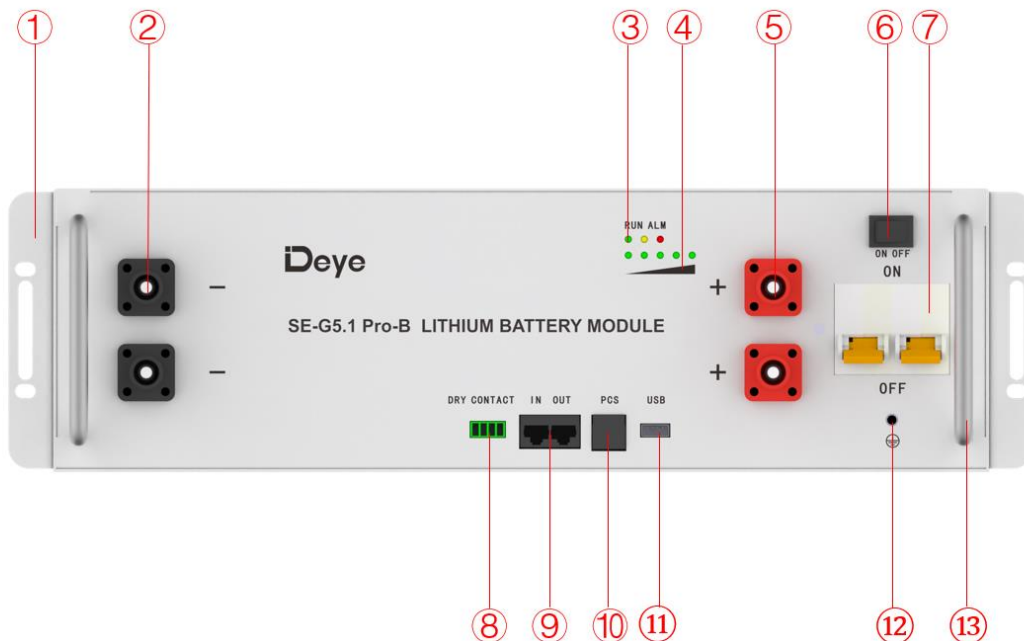

Figure 2-1: Front Panel Function Introduction

1. Used for fixing with cabinet.
2. Negative output terminal.
3. RUN light: green LED lighting to show the battery running status  
Alarm light: yellow and red LED lighting to show the battery has been alarmed or protected.
4. SOC: These 5 LEDs are used to display the pack SOC. The lightning of these LEDs indicates the SOC of 20%, 40%, 60%,80% and 100%.
5. Positive output terminal.
6. Power button: to turn ON/OFF the whole battery BMS standby, no power output.
7. Miniature circuit breaker: Control total positive and negative circuit off and on.
8. DRY CONTACT output.
9. IN: parallel Communication Terminal: (RJ45 port) Connect "out" Terminal of Previous battery, for communication between multiple parallel batteries.  
OUT: parallel Communication Terminal: (RJ45 port) Connect "IN" Terminal of Next battery, for communication between multiple parallel batteries.
- 10.PCS: Inverter communication terminal: (RJ45 port) follow the CAN protocol (baud rate: 500kbps), and RS-485(baud rate: 9600bps), used to output battery information to the inverter.
- 11.USB: (USB port) Used to insert USB flash drive for battery upgrade.
- 12.Grounding bolt.
- 13.Handle: It was used to carry/move the battery.

## 2.2 Product Specifications

Table 2-1: Product Specifications

Main Parameter		SE-G5.1 Pro-B
Battery Chemistry		LiFePO4
Capacity (Ah)		100
Scalability		Max. 64 pcs pack (327kWh) in parallel (Max. 32 pcs no external setup)
Nominal Voltage (V)		51.2
Operating Voltage(V)		43.2~57.6
Energy (kWh)		5.12
Usable Energy (kWh) <sup>[1]</sup>		4.61
Charge/Discharge Current (A)	Recommend <sup>[2]</sup>	50
	Max. <sup>[2]</sup>	100
	Peak(2mins,25℃)	150
Other Parameter		
Recommend Depth of Discharge		90%
Dimension (W/H/D, mm)		445*133*540
Weight Approximate(kg)		45
Master LED indicator		5LED(SOC:20%~100%)
		3LED (working, alarming, protecting)
IP Rating of enclosure		IP20
Working Temperature		Charge:0℃~55℃ Discharge:-20℃~55℃

Storage Temperature	0°C~35°C
Humidity	5%~95%
Altitude	≤2000m
Cycle Life	≥6000(25°C±2°C,0.5C/0.5C,90%DOD,70%EOL)
Installation	Wall-Mounted, Floor-Mounted, Rack-Mounted (19-inch standard cabinet, cabinet depth ≥600mm)
Communication Port	CAN2.0, RS485
Certification	UN38.3, IEC62619, CE,UKCA, VDE2510-50, FCC, UL1973, UL9540A, REACH, ROHS

[1] DC Usable Energy, test conditions: 90% DOD, 0.5C charge & discharge at 25°C. System usable energy may vary due to system configuration parameters.



[2] The current is affected by temperature and SOC.

## 2.3 State Indicator

Condition	RUN	ALM	ERROR	SOC1	SOC2	SOC3	SOC4	SOC5
Power Off	Off							
Discharge or Idle	Blink	Blink if Alarm Exists	Off	e.g., Soc67%:				
			Off	On	On	On	On	
Charge		Blink	Blink	Off	e.g., Soc47%:			
	Off			Off	Blink	On	On	
Alarm			Off	Same as 'Discharge or Idle'				
System Error/Protection			On					
Upgrade	Blink Fastly							
Critical Error	Blink Slowly							

## 3. Unpack the Battery

The battery and the related accessories are packed in the carton box. Use tools to open the packing box. After open the packing box, confirm the product components according to the parts list.

	
	<p>Violent unpacking is strictly prohibited. If the battery system is found to be broken, deformed or other abnormal conditions, the user shall immediately stop using the battery and contact us.</p>

### 3.1 Parts List

Check the parts during unpacking.

Table 3-1: Parts Lists















No.	Items	Appearance	Usage	Qty.	Remarks
1	Battery		Provide power	1	
2	3U-LBCable150		Pair of 150mm 4AWG Battery power cable(both ends have waterproof terminals) and one 250mm RJ45 communication cable for battery parallel.	1	
3	3U-LPCable1500		Pair of 4AWG DC power cable (one end has a waterproof terminal, the other end is M10 copper terminal) and one RJ45 communication cable connect with hybrid inverter. The default length is 1500mm.	1	
4	10AWG yellow-green ground line 300mm		Battery ground line	1	
5	M6*16 Cabinet bolt		Fix the battery on the rack or cabinet	4	
6	Battery Rack Fixed Ears and M4*8 bolt		Used for battery fixing with 19inch rack or cabinet	2 ears 6 bolts	
7	Simple stacking bracket		Used for battery stacking and securing	4pcs	
8	Wall bracket		Used for battery pack wall mounting	2	
9	M6 Expansion		Fixed Wall bracket	4	
10	User manual	/	/	1	



Table 3-2: Recommended Tools and Instruments

No.	Items	Usage	Appearance
1	Phillips Screwdriver or Bit	To fasten battery and assemblies	
2	Box Cutter	Opening boxes	
3	Insulated Torque Wrench	Installing cables and busbars	
4	Insulated Sockets	Installing cables and busbars	
5	Battery Tester	Measure battery module's voltage	



### 3.2 Visual Inspection of the Modules

After transporting the modules to the installation location, check for:

- Physical damage to the exterior
- Damaged or protruding screws

## 4. Battery Installation

This system must be installed by qualified, trained workers familiar with the required instruments.

	
	<ul style="list-style-type: none"> <li>▪ Be sure to use insulated tools (torque wrench, extension, socket, etc.).</li> <li>▪ All the instruments must be insulated and no metal articles (e.g., watch, ring) should be present in the installation area.</li> <li>▪ All power switches must be turned off in advance.</li> <li>▪ Prepare a CO<sub>2</sub> fire extinguisher, a first aid kit, and an AED (automated external defibrillator) before installation.</li> </ul>

	<b>⚠ WARNING</b>
	Arc Flash and Shock Hazard Insulated tools are required for any work on this energized equipment.

	<b>⚠ WARNING</b>
	Sharp Edges Wear gloves and other protective gear to prevent injury.

	<b>⚠ WARNING</b>
	Pinch Point Use caution when working in the enclosure to prevent injury.

	<b>⚠ CAUTION</b>
	Heavy Object Can cause muscle strain or back injury. Use lifting aids and proper lifting techniques when moving trays, batteries, and other heavy objects.

## 4.1 Battery Module Installation

1. Transport battery modules to the installation location.
2. Place the battery modules on the bracket or rack or cabinet.
3. Fix the battery on the bracket or rack. Using the bracket or cabinet bolt to fix the battery into the bracket or rack.
4. After installation, tighten all bolts.

Installation method 1: With simple bracket installation



Installation method 2: With standard 19 inches cabinet or rack installation

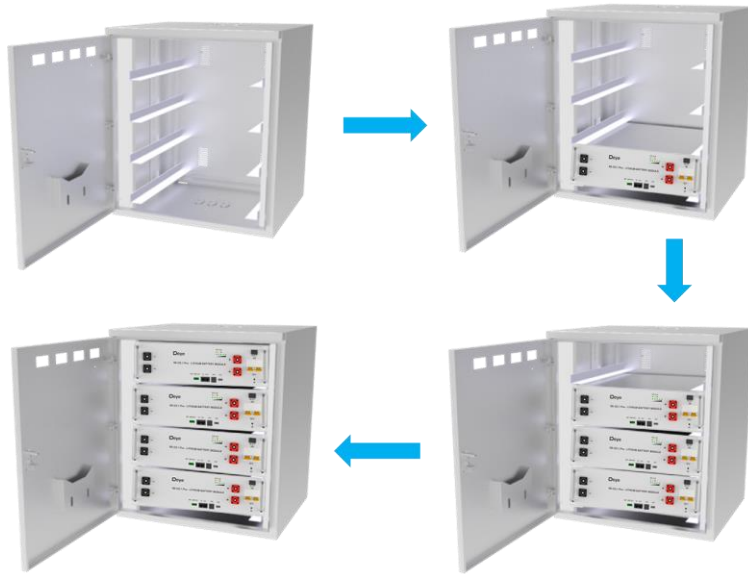

	<b>IMPORTANT</b>
	<ul style="list-style-type: none"><li>▪ The battery can be mounted on a standard 19 inches cabinet or rack.</li><li>▪ Battery modules can be inserted into a rack frame according to the customer battery configuration scheme.</li></ul>

Installation method 3: Wall-mounted method

The installation location description should meet the size requirements of the figure below:

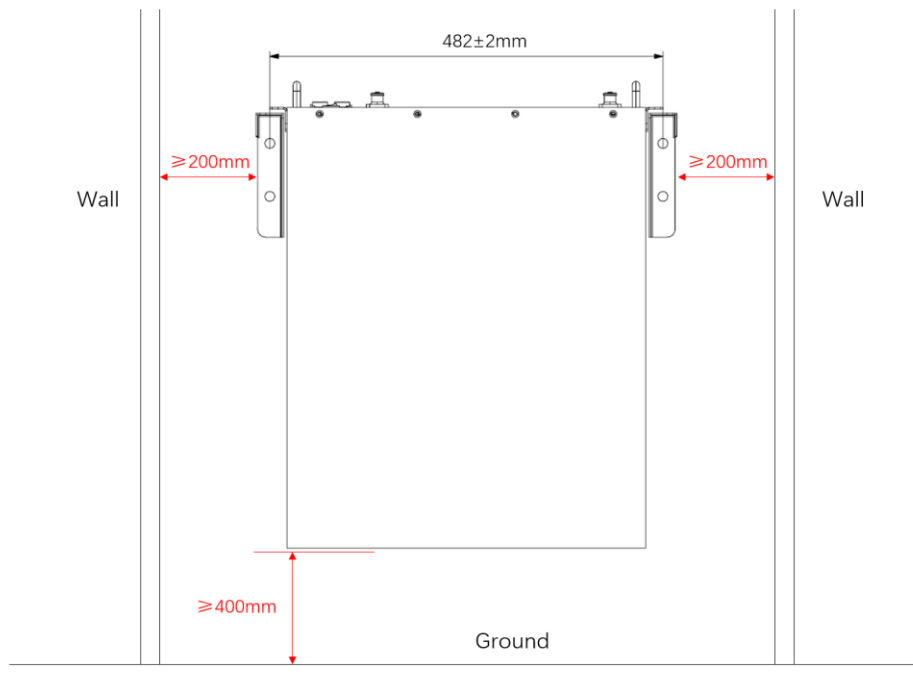

Figure 4-1

a) Use the 6 screws of M4\*8 to fix the battery pack Fixed Ears the both sides battery, as show in Figure 4-2.



M4\*8 screws

Use the 6 screws of M4\*8 to fix the battery pack Fixed Ears the battery both end.

Figure 4-2

b) Choose the recommend drill head (as shown in Figure 4-3) to drill 4 holes on the wall,100mm-110mm deep.

c) Use a hammer to secure the support to the wall, and install the expansion bolt in the hole, as shown in Figure 4-3.

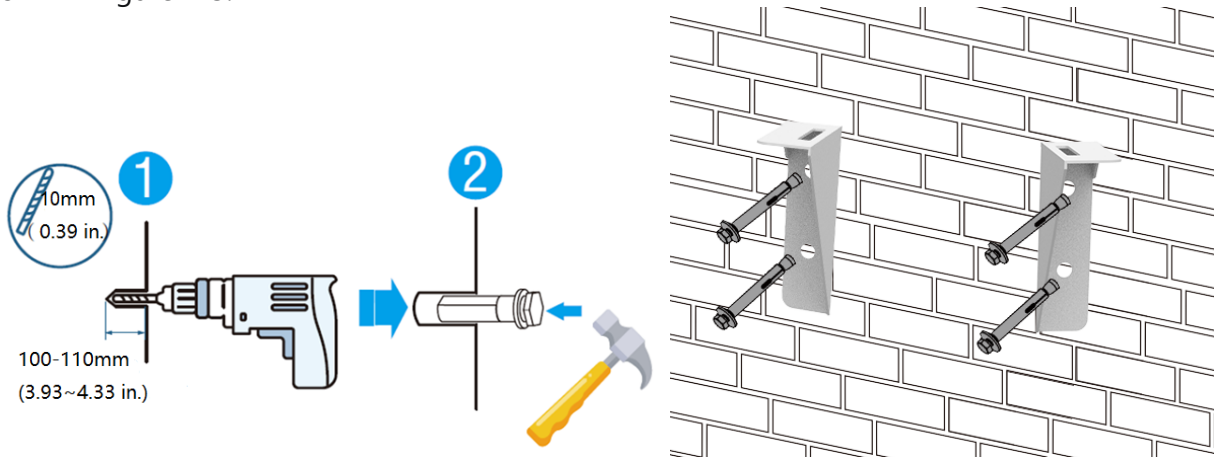

Figure 4-3

d) Fasten the screw head of the expansion bolt to finish the mounting.

e) Carry the battery and hold it. Fix the battery to the support after fixing it to the wall.

Ensure that battery mounting ears are aligned with the left and right holes on the support, as shown in Figure 4-4.

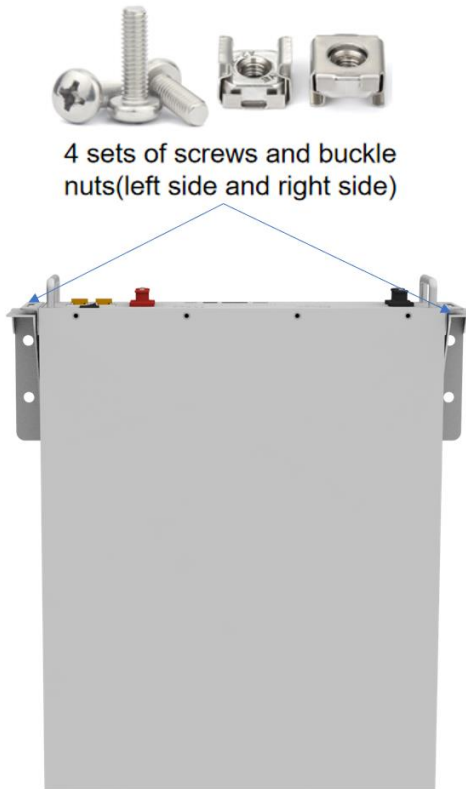

Figure 4-4





- The battery can be mounted on a standard 19 inches cabinet or rack.
- Battery modules can be inserted into a rack frame according to the customer battery configuration scheme.

**Note the allowable installation modes.**



# 5. Cable Connection

## 5.1 Single Battery Connection

	<p style="text-align: center;"><b>NOTICE</b></p> <ul style="list-style-type: none"><li>▪ Before connect the cable with the inverter, the worker must confirm the output switch of the inverter has been turn off, to prevent the risk of fire or electric shock.</li></ul>
	<p style="text-align: center;"><b>CAUTION</b></p> <ul style="list-style-type: none"><li>▪ Before connection, make sure to close the battery.</li><li>▪ Please follow the instructions to protect the module BMS against damage.</li><li>▪ DO NOT deviate from the sequence of steps below.</li><li>▪ Exercise extreme caution prevent the terminals from contacting anything except their intended mounting points.</li><li>▪ Terminals and their connected wires have either positive or negative polarity (Positive: +; Negative-). The polarity of a terminal or a wire connected to the terminal is on the front of each module. Exercise extreme caution to prevent the terminals and/or wires with opposite polarity from contacting with each other.</li><li>▪ The maximum voltage of the battery is no more than 60V, which is higher than the safe voltage of 36V. Therefore, we still recommend that the battery terminals or other exposed parts should not be directly touched during the</li></ul>
	<p style="text-align: center;"><b>NOTICE</b></p> <ul style="list-style-type: none"><li>▪ When tightening the screws, make sure they are at a straight angle from the battery module terminals to avoid damage to the nuts inside.</li><li>▪ Assemble the screws using a Phillips-head within the fastening torque of less than 8.0 Nm (81.5 kgf•cm).</li></ul>
	<p style="text-align: center;"><b>IMPORTANT</b></p> <ul style="list-style-type: none"><li>▪ The power terminals, such as “+,” “-,” of the module are covered with the protecting cover to guard against a short circuit (Shown in Figure 5-1).</li><li>▪ You must remove the insulation cover prior to connecting and reattach the insulation cover immediately after connecting.</li></ul>

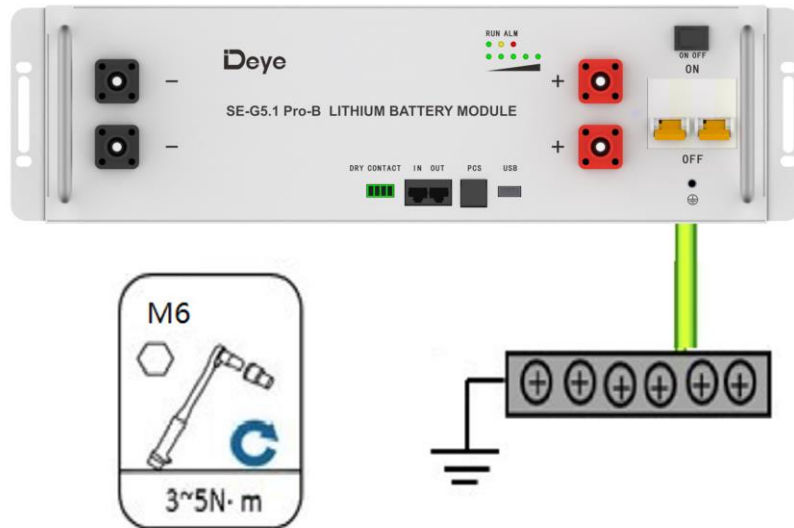

Figure 5-1: Install the Grounding Wire

Step 1 Wear the protective gloves.

Step 2 Install the battery ground cable.

Step 3 Install negative and positive power cables for the battery.

- 1) Remove the protective cover from the battery power wiring terminal.
- 2) Connect the negative power cable to the battery.
- 3) Connect the positive power cable to the battery.
- 4) Install the other end of the battery power cables at a battery route and the corresponding busbar in the power system.
- 5) Reinstall the protective cover on the battery power wiring terminals.

Connect the inverter:

- 1) Remove the protecting cover.
- 2) Take-down positive fixing bolt by the Phillips Screwdriver and connect the positive output cable between the battery positive terminal of the battery and the inverter. After connecting the battery, fastening bolt immediately to avoid dropping.

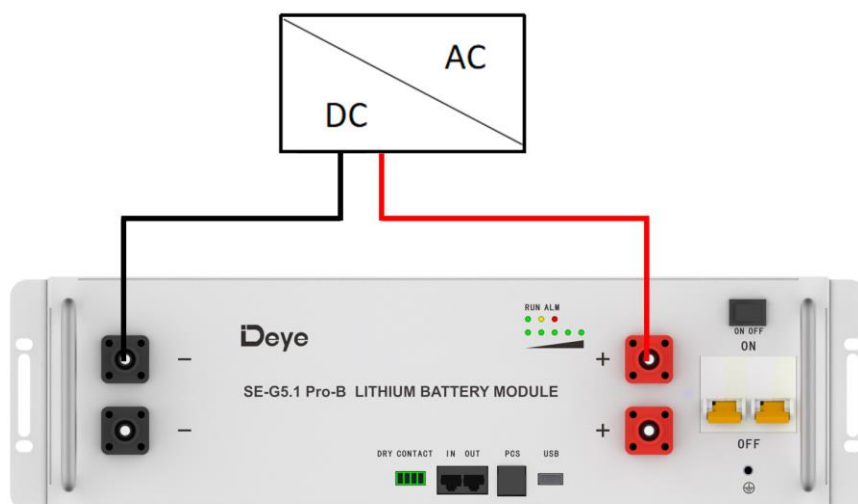

Figure 5-2: Single Battery Connection

- 3) Take-down negative fixing bolt by the Phillips Screwdriver and connect the negative output cable between the battery negative terminal of the battery and the inverter. After connecting the battery, fastening bolt immediately to avoid dropping.
- 4) Install the protecting cover.
- 5) Sort the cables and fasten the battery cables to the perforated bracket with cable ties.
- 6) Communication Line Connection

As shown in Figure 5-3, when monitoring the battery by the computer, connect the 'USB convert CAN Box communication line between battery and computer.

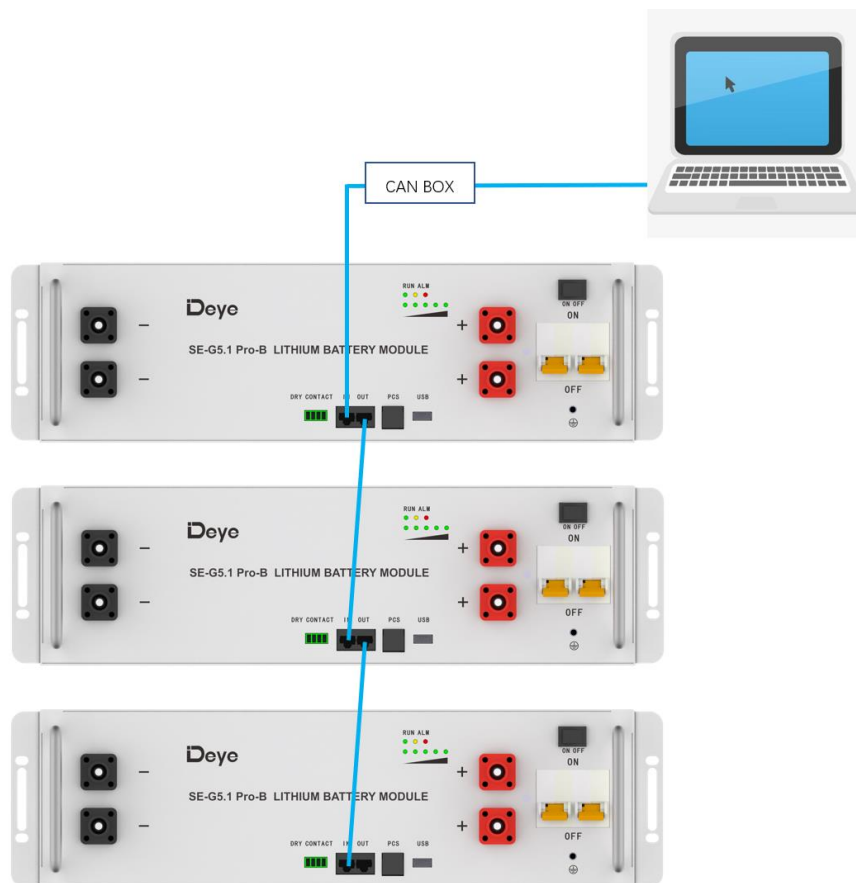

Figure 5-3: Communication Cable Connections between Battery and Computer

## 5.2 Connect Cables of the Multiple Batteries in Parallel

5.2.1. When multiple batteries in parallel, the cable connecting procedures are follows.

### 1. Parallel mode1 (4 batteries suitable for scenarios where the inverter power $\leq 12\text{kW}$ )

For 4 batteries, it should be noted that the maximum current of **the first battery is 240A (inverter power must not exceed 12kW)**, exceeding 240A will cause heating of the connectors and cable, and In severe cases, it will cause a fire accident.

Schematic diagram of parallel connection of low-power system batteries:



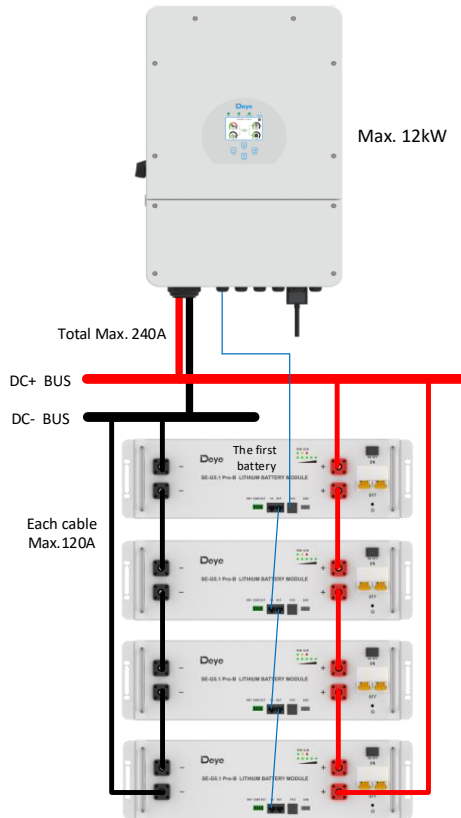

**If the inverter power exceeds 12kW, the parallel mode must be used mode 2!**

**2. Parallel mode2 (It is suitable for scenarios where the inverter power > 12kW)**

Schematic diagram of parallel connection of high-power system batteries:

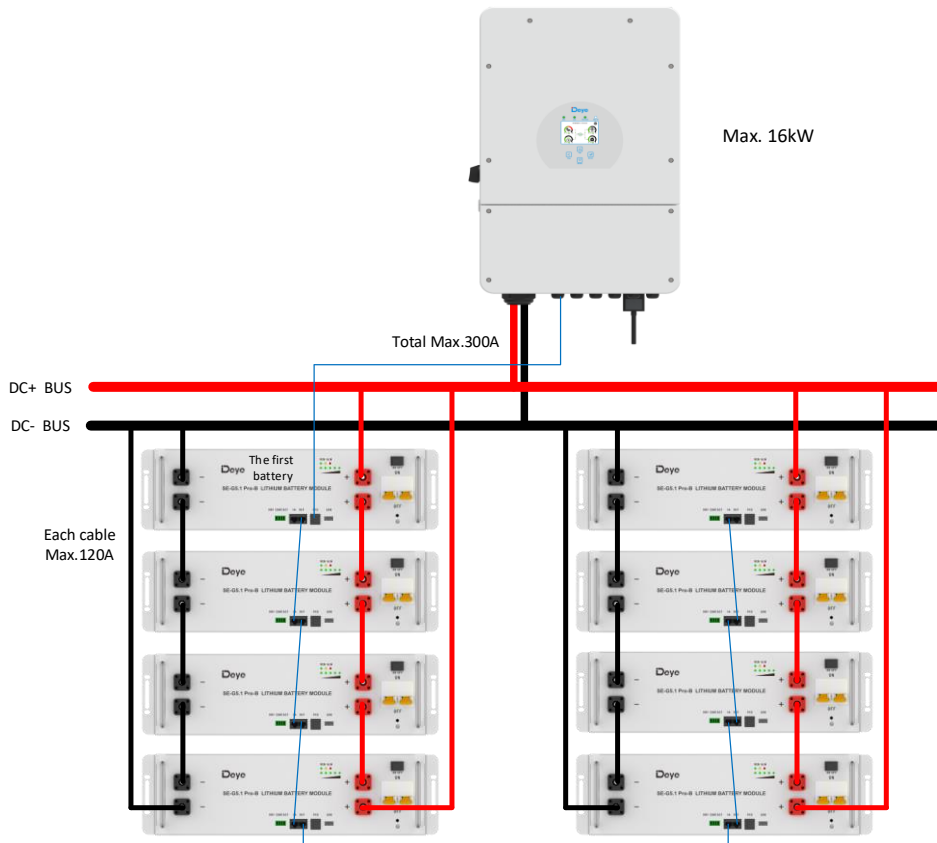

**Or larger capacity systems:**



5.2.2. As shown in 5.2.1, connect the communication line (a standard RJ45 network cable) between the adjacent batteries.

**Note:** The **PCS Port** of the first battery must be connected to the inverter's battery communication interface, otherwise the inverter cannot communicate with the batteries.

**Note:** The **OUT Port** of the first battery is connected to the **IN Port** of the next battery, and so on, connecting the communication of multiple batteries together, otherwise multiple batteries will not be able to communicate correctly.

5.2.3. Connect the communication line between battery and inverter

(1) PCS Port Definition

Definition of PCS Port Pin

No.	PCS Port Pin
1	485-B
2	485-A
3	—
4	CANH
5	CANL
6	—
7	485-A
8	485-B



## (2) IN Port Definition

Definition of IN Port Pin

No.	PCS Port Pin
1	CANL
2	CANH
3	DI+
4	DI-
5	DI-
6	DI+
7	CANH
8	CANL



## (3) OUT Port Definition

Definition of Out Port Pin

No.	Out Port Pin
1	CANL
2	CANH
3	DO+
4	DO-
5	DO-
6	DO+
7	CANH
8	CANL



## 5.3 Visual Inspection of the Connection

After connecting the battery, check for:

- Usage of positive and negative cables.
- Connection of the positive and negative terminals.
- All the bolts are tightened.
- Cables fixation and the appearance.
- The communication cable is connected correctly.
- The installation of the protecting cover.

## 6. Activate the Product

### 6.1 Start the Battery

- A. Hang the battery on the wall as shown on 4.2.
- B. Connect the wires according to the picture on 5.
- C. Close the Air Switch first, and then turn on the Power Button to prevent battery short-circuit protection failure caused by the pre-charge function.

Start the Battery:

After installation, wiring, and configuration are completed, you must check all the connection. When the connections are correctly, and then press power button to activate the battery. The green working light on of the battery flashes, indicating that the battery system is normal.

## 7. Inspection, Cleaning and Maintenance

### 7.1 General Information

- The battery product is not fully charged. It is recommended that the installation be completed within 3 months after arrival;
- During the maintenance process, do not re-install the battery in the battery product. Otherwise, the performance of the battery will be reduced;
- It is forbidden to dismantle any battery in the battery product, and it is forbidden to dissect the battery;
- After the battery product is over-discharged, it is recommended to charge the battery within 48 hours. The battery product can also be charged in parallel. After the battery product is connected in parallel, the charger only needs to connect the output port of any product battery.
- Never attempt to open or dismantle the battery! The inside of the battery does not contain serviceable parts.
- Disconnect the Li-Ion battery from all loads and charging devices before performing cleaning and maintenance activities
- Place the enclosed protective caps over the terminals before cleaning and maintenance activities to avoid the risk of contacting the terminals.

### 7.2 Inspection

- Inspect for loose and/or damaged wiring and contacts, cracks, deformations, leakage, or damage of any other kind. If damage to the battery is found, it must be replaced. Do not attempt to charge or use a damaged battery. Do not touch the liquid from a ruptured battery.
- Regularly check the battery's state of charge. Lithium Iron Phosphate batteries will slowly self-discharge when not in use or whilst in storage.
- Consider replacing the battery with a new one if you note either of the following conditions:
  - The battery run time drops below 70% of the original run time.
  - The battery charge time increases significantly.

### 7.3 Cleaning

If necessary, clean the Li-Ion battery with a soft, dry cloth. Never use liquids, solvents, or abrasives to clean the Li-Ion battery.

## 7.4 Maintenance

The Li-Ion battery is maintenance free. Charge the battery to approximately > 80% of its capacity at least once every year to preserve the battery's capacity.

## 7.5 Storage

- The battery product should be stored in a dry, cool, and cool environment;
- Generally, the maximum storage period at room temperature is 6 months. When the battery is stored over 6 months, it is recommended to check the battery voltage. If the voltage is higher than 51.2V, it can continue to store the battery. In addition, it is needed to check the voltage at least once a month until the voltage is lower than 51.2V. When the voltage of the battery is lower than 51.2V, it must to be charged according to the charging strategy.
- The charging strategy is as follows: discharge the battery to the cutoff voltage with  $0.2C_{10}A$  current, and then charge with  $0.2C_{10}A$  current for about 3 hours. Keep the SOC of the battery at 40-70% when stored;
- When the battery product is stored, the source of ignition or high temperature should be avoided and it should be kept away from explosive and flammable areas.

## 8. Troubleshooting

To determine the status of the battery system, users must use additional battery status monitoring software to examine the protection mode. Refer to the installation manual about using the monitoring software. Once the user knows the protection mode, refer to the following sections for solutions.

Table 8-1: Troubleshooting

Fault Type	Fault Generation condition	Possible Causes	Troubleshooting
BMS fault	The cell voltage sampling circuit is faulty. The cell temperature sampling circuit is faulty	The welding point for cell voltage sampling is loose or disconnected. The voltage sampling terminal is disconnected. The fuse in the voltage sampling circuit is blown. The cell temperature sensor has failed.	Replace the battery.
Electrochemical cell fault	The voltage of the cell is low or unbalanced.	Due to large self- discharge, the cell over discharges to below 2.0V after long term storage. The cell is damaged by external factors, and short circuits, pinpricks, or crushing occur.	Replace the battery.
Overvoltage protection	The cell voltage is greater than 3.65 V in charging state. The battery voltage is greater than 58.4 V.	The busbar input voltage exceeds the normal value. Cells are not consistent. The capacity of some cells deteriorates too fast or the	If the battery cannot be recovered due to protection against abnormality contact local engineers to

		internal resistance of some cells is too high.	rectify the fault.
Under voltage protection	The battery voltage is less than 40V. The minimum cell voltage is less than 2.5V	The mains power failure has lasted for a long time. Cells are not consistent. The capacity of some cells deteriorates too fast or the internal resistance of some cells is too high.	Same as above.
Charge or discharge high temperature protection	The maximum cell temperature is greater than 60°C	The battery ambient temperature is too high. There are abnormal heat sources around	Same as above.
Charge low temperature protection	The minimum cell temperature is less than 0°C	The battery ambient temperature is too low.	Same as above.
Discharge low temperature protection	The minimum cell temperature is less than -20°C	The battery ambient temperature is too low.	Same as above.

By checking the above data and sending the data to the service personnel of our company, the service personnel of our company will reply the corresponding solution after receiving the data.

## 9. Battery recovery

Aluminum, copper, lithium, iron and other metal materials are recovered from discarded LiFePO<sub>4</sub> batteries by advanced hydrometallurgical process, and the comprehensive recovery efficiency can reach 80%. The specific process steps are as follows:

### 9.1 Recovery process and steps of cathode materials

Aluminum foil as collector is amphoteric metal. Firstly, it is dissolved in NaOH alkali solution to make aluminum enter the solution in the form of NaAlO<sub>2</sub>. After filtration, the filtrate is neutralized with sulfuric acid solution and precipitated to obtain Al(OH)<sub>3</sub>. When the pH value is above 9.0, most of the aluminum precipitates, and the obtained Al(OH)<sub>3</sub> can reach the level of chemical purity after analysis.

The filter residue is dissolved with sulfuric acid and hydrogen peroxide, so that lithium iron phosphate enters the solution in the form of Fe<sub>2</sub>(SO<sub>4</sub>)<sub>3</sub> and Li<sub>2</sub>SO<sub>4</sub>, and is separated from carbon black and carbon coated on the surface of lithium iron phosphate. After filtration and separation, the pH value of the filtrate is adjusted with NaOH and ammonia water. First, iron is precipitated with Fe(OH)<sub>3</sub>, and the remaining solution is precipitated with saturated Na<sub>2</sub>CO<sub>3</sub> solution at 90 °C. Since FePO<sub>4</sub> is slightly dissolved in nitric acid, the filter residue is dissolved with nitric acid and hydrogen peroxide, which directly precipitates FePO<sub>4</sub>, separates impurities such as carbon black from acid solution, leaches Fe(OH)<sub>3</sub> from filter residue respectively, and precipitates Li<sub>2</sub>CO<sub>3</sub> with saturated Na<sub>2</sub>CO<sub>3</sub> solution at 90 °C.

## 9.2 Recovery of anode materials

The recovery process of anode materials is relatively simple. After the separation of anode plates, the purity of copper can be more than 99%, which can be used for further refining electrolytic copper.

## 9.3 Recovery of diaphragm

The diaphragm material is mainly harmless, and has no recycling value.

## 9.4 List of recycling equipment:

Automatic dismantling machine, pulverizes, wet gold pool, etc.

# 10. Transportation Requirements

The battery products should be transported after packaging and during the transportation process, severe vibration, impact, or extrusion should be prevented to prevent sun and rain. It can be transported using vehicles such as cars, trains, and ships.

Always check all applicable local, national, and international regulations before transporting a Lithium Iron Phosphate battery.

Transporting an end-of-life, damaged, or recalled battery may, in certain cases, be specially limited or prohibited.

The transport of the Li-Ion battery falls under hazard class UN3480, class 9. For transport over water, air and land, the battery falls within packaging group PI965 Section I.

Use Class 9 Miscellaneous Dangerous Goods and UN Identification labels for transportation of lithium-ion batteries which are assigned Class 9. Refer to relevant transportation documents.

Lithium batteries and lithium-ion cells are regulated in the U.S. in accordance with Part 49 of the Code of Federal Regulations, (49 CFR Sections 105-180) of the U.S. Hazardous Materials Regulations.



Figure 10-1: Class 9 Miscellaneous Dangerous Goods and UN Identification Label